

Yorktown Fire Department



Fire Safety Activity Book

Iggy the Fire Tiger is visiting the community for fire safety week. He cannot wait to help the children learn more about fire safety. He also hopes to teach the children more about the Yorktown Fire Department.

The Yorktown Fire Department
is located at
8905 W. Smith St.
Yorktown, IN 4739.

Its non-emergency phone number is
(765) 759-5836.



Hello everyone,
my name is Iggy!
Today we are learning
about fire safety.





Do not be scared of my gear. Firefighters are here to protect you. Circle the right items for me to wear.

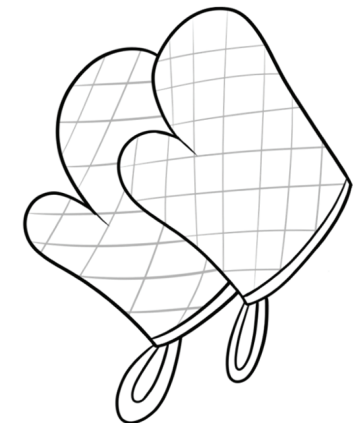
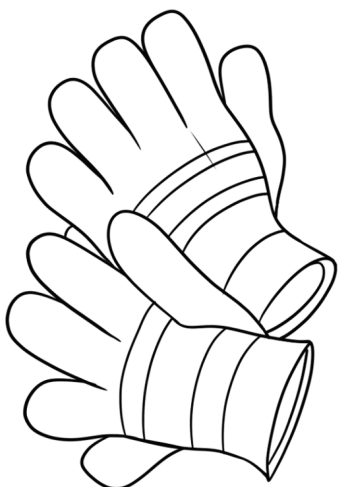
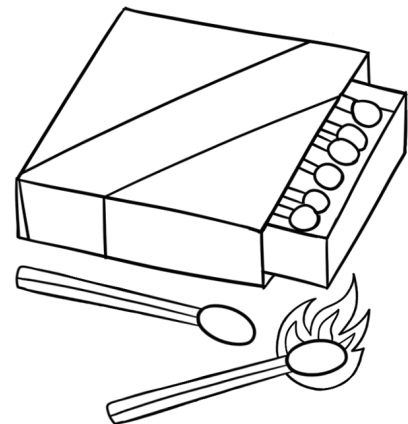
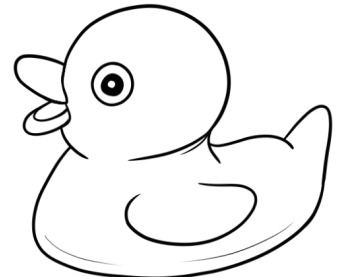
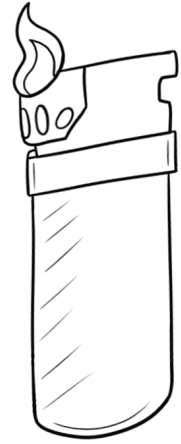
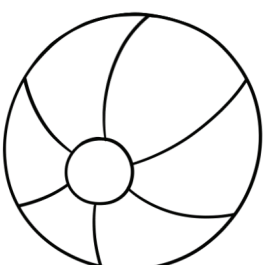
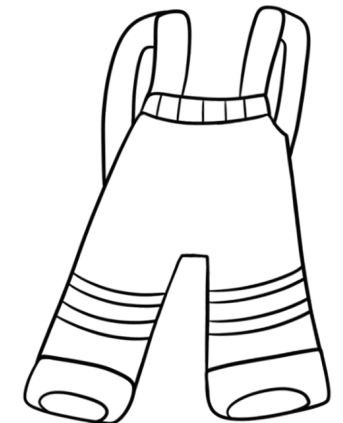
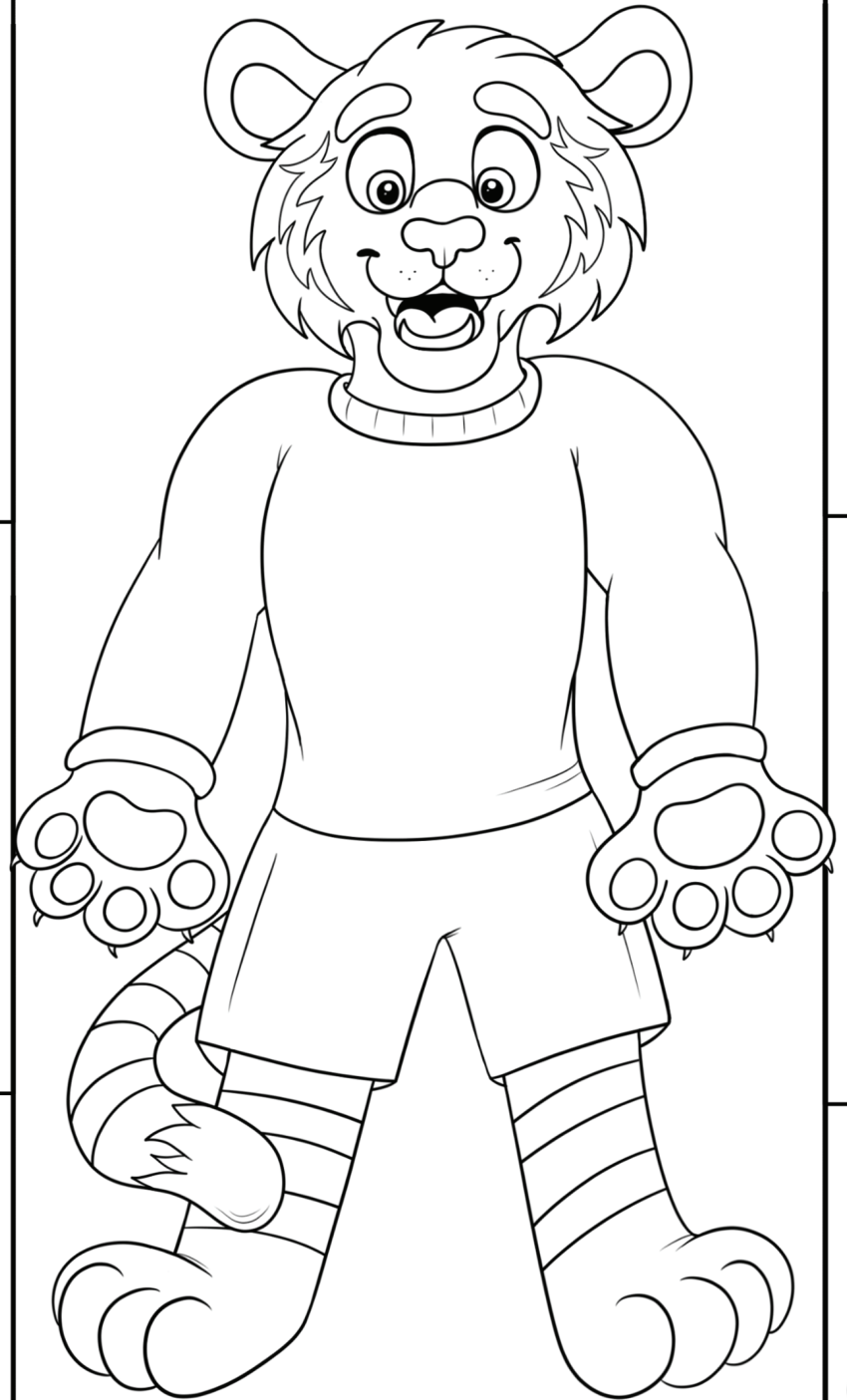
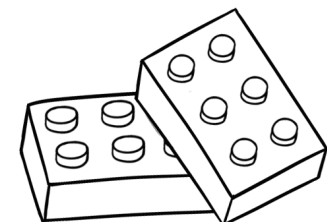
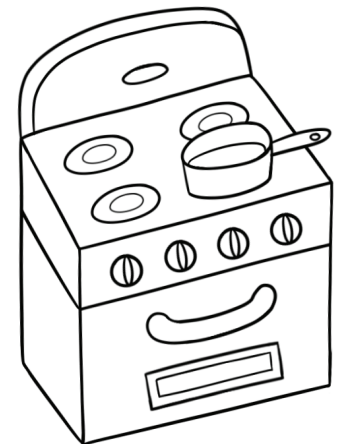
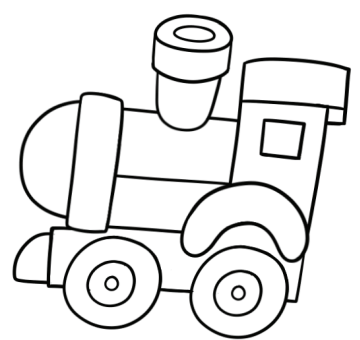
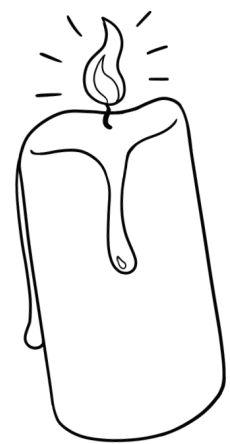

Fire can be dangerous, so we do not play with it. Circle which objects are safe to touch.

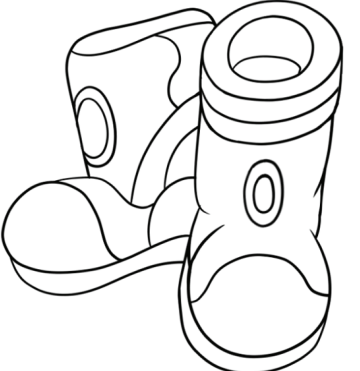
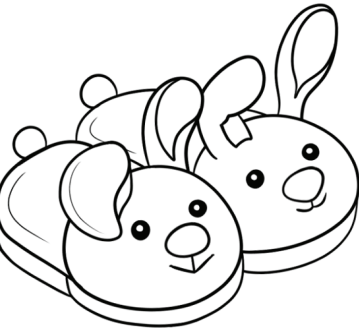

If a fire starts,
it is important to
know what to do.

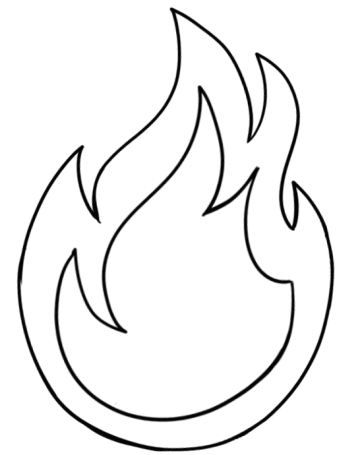

Never open a door that
is hot. Connect the dots
to feel the door first.

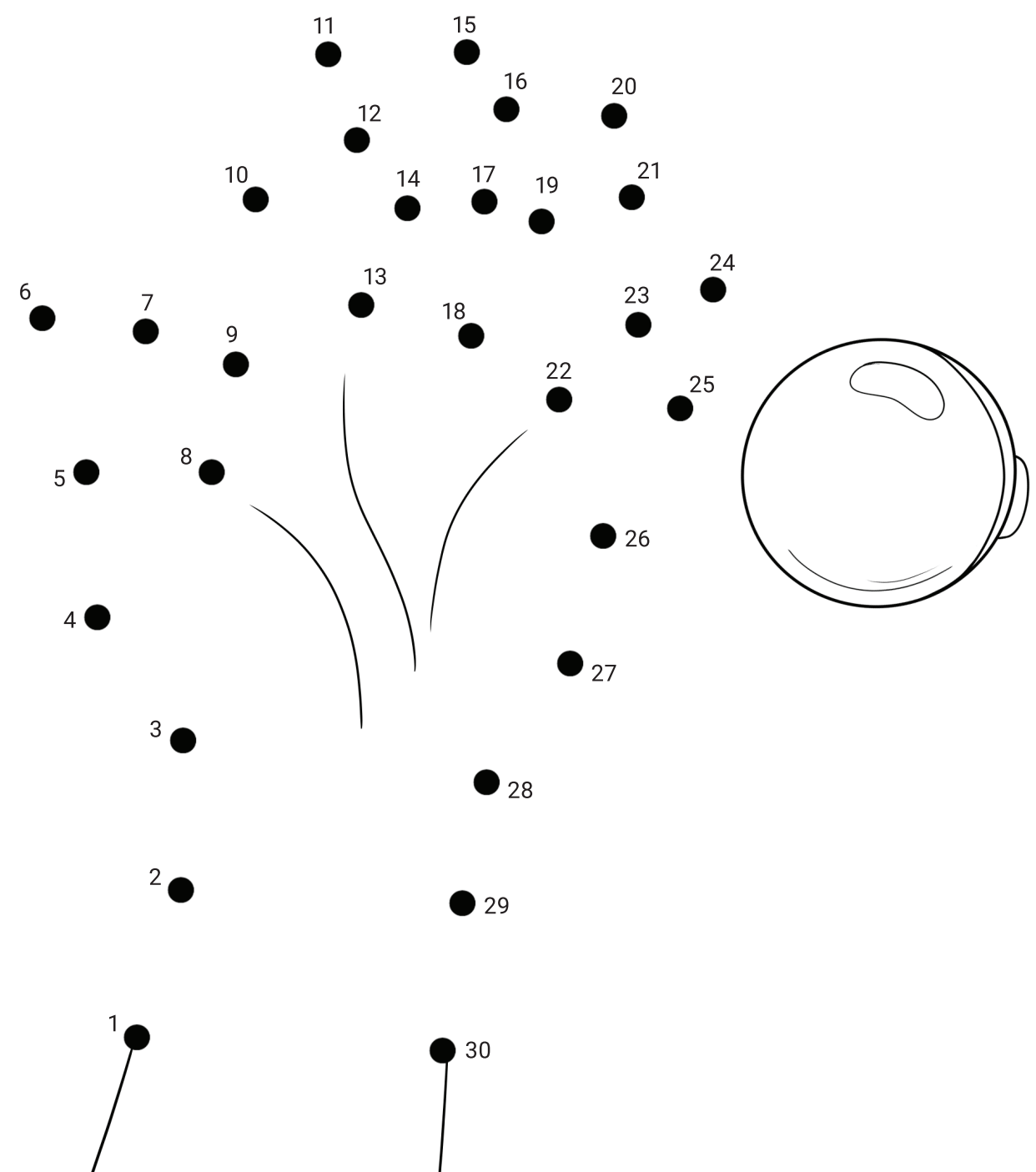



Do not hide, find a door or a window to exit your room. Draw your room showing two ways out.

Make sure to sleep with your bedroom door closed. It can prevent a fire from spreading.

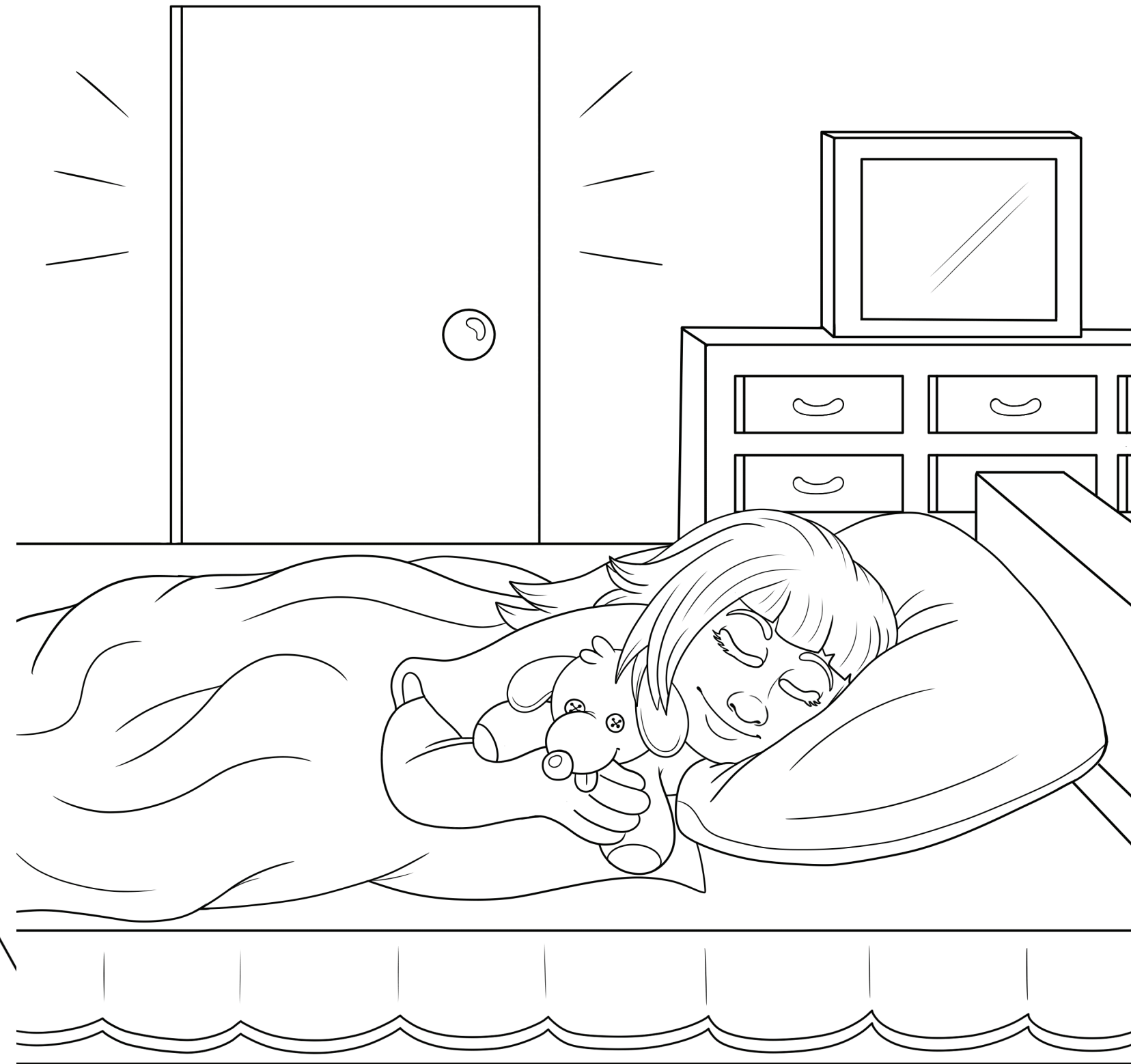
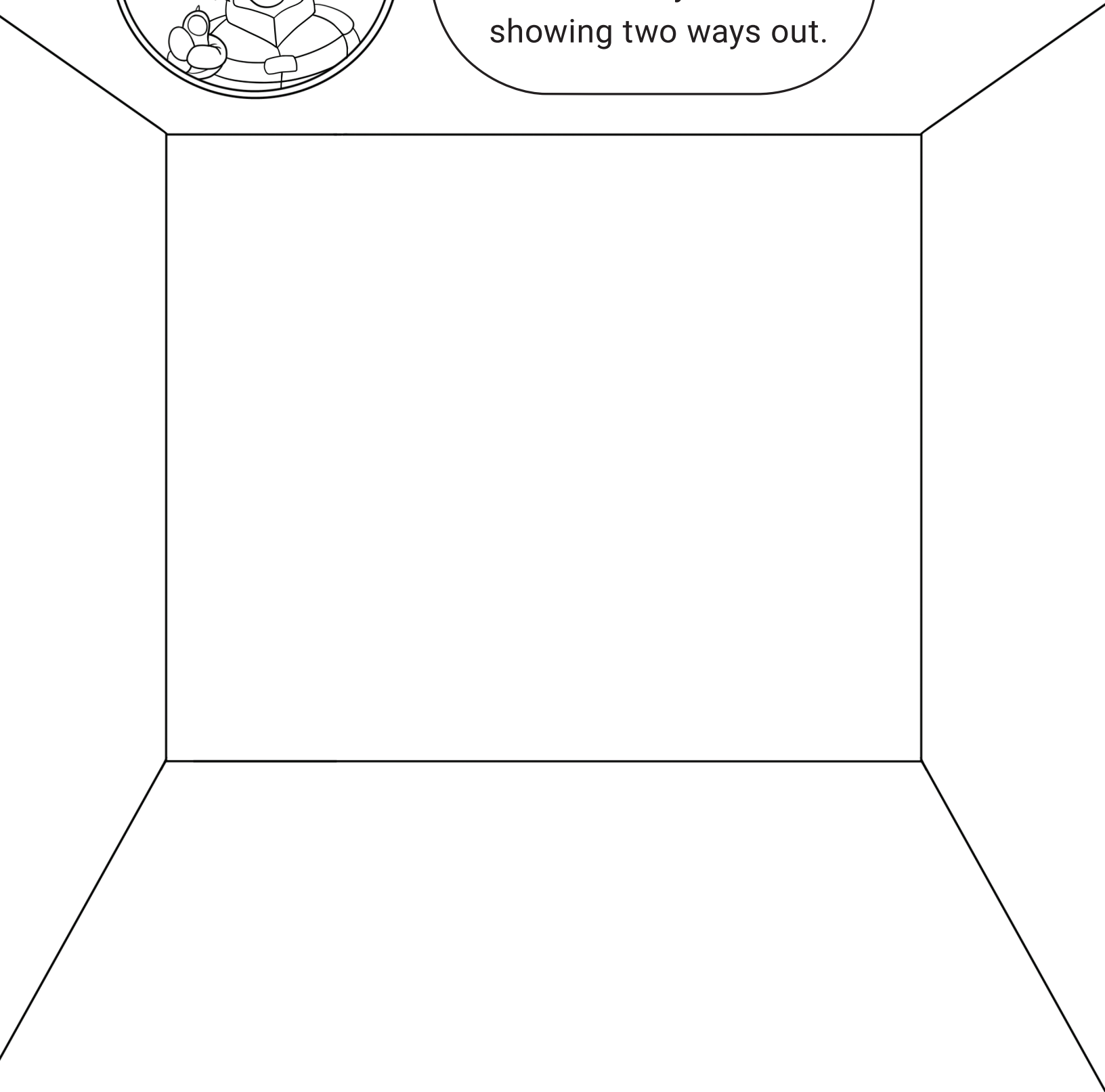

Get low,
get out!



Do not go back
for your toys.
Leave your things
where they are.

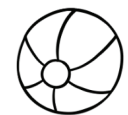
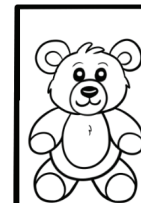

END



Get low, get out, crawl!
Draw yourself moving
low under the smoke.



Stop 

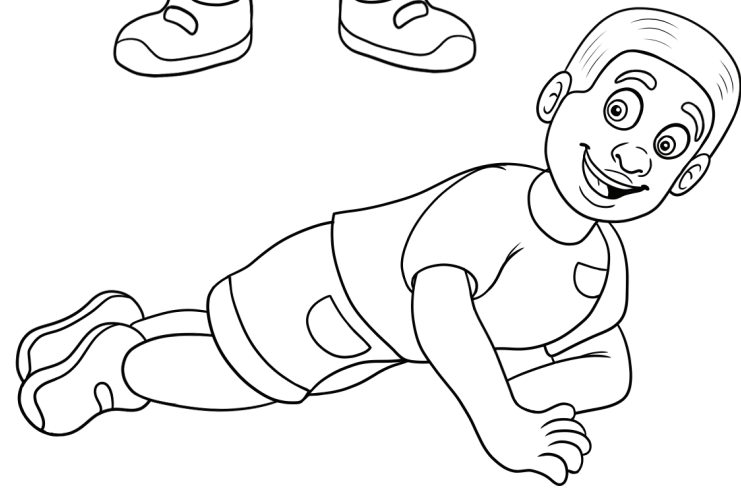

Drop 

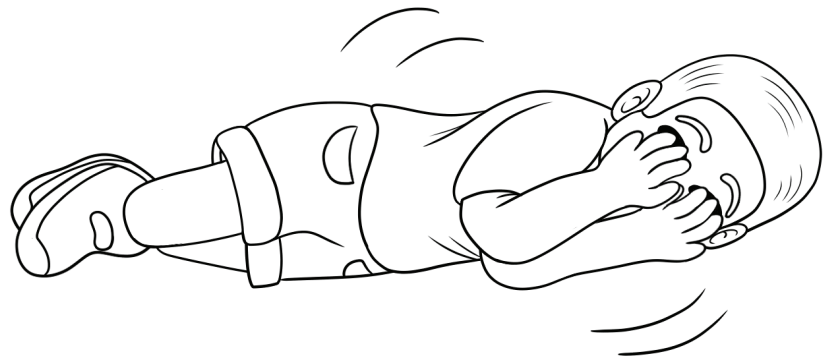

Roll 



If your clothes catch fire, remember to stop, drop and roll. Try it yourself or with a friend.

Ask a parent or guardian to check your fire alarm and extinguisher.

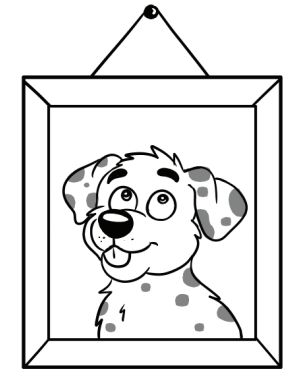

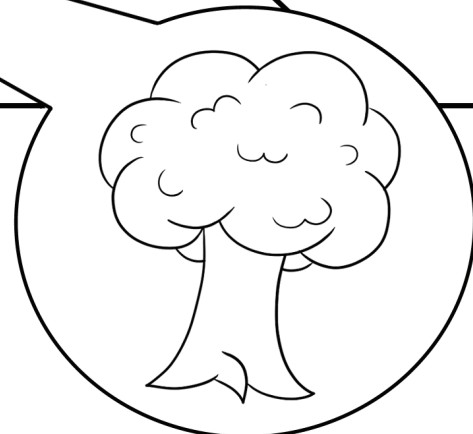
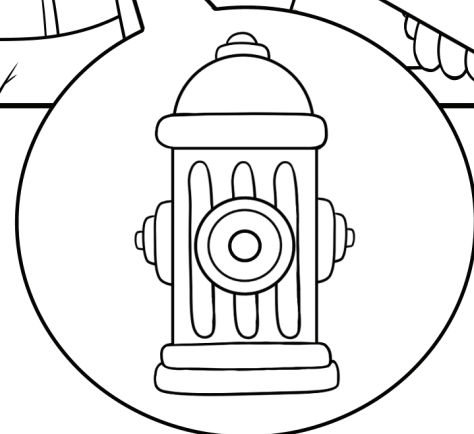
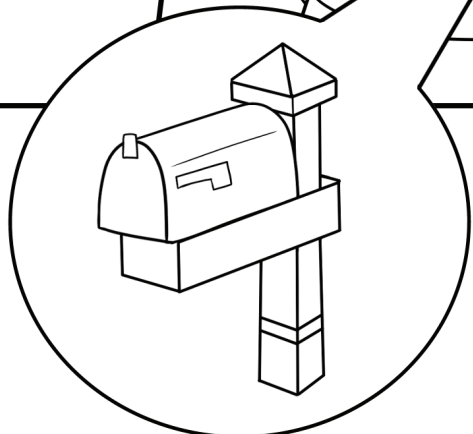
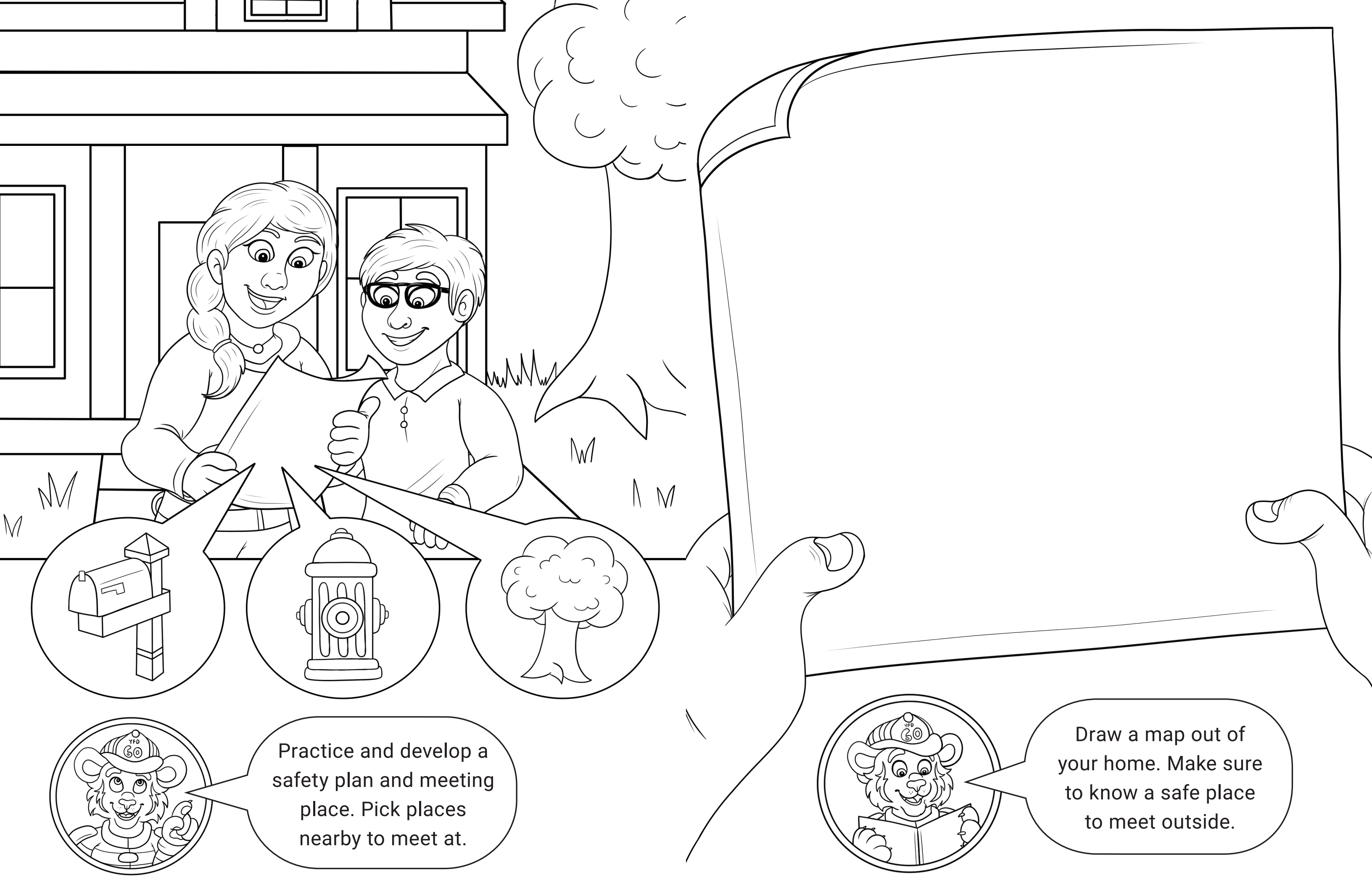

Practice and develop a safety plan and meeting place. Pick places nearby to meet at.



Draw a map out of your home. Make sure to know a safe place to meet outside.

Call 911 if there is a fire.
Make sure to know your
fire safety information.

My Fire Safe Information

Name: _____

Address: _____

Phone: _____



As Iggy drives back to the Yorktown Fire Department, he thinks about all of the people who were able to help him tell his story. He wants to thank each of them personally.

I'm thankful that Ashley Allegretti helped design and illustrate this book.

I am also thankful for Ashlyn Sterling and Jaclyn Grutsch for their help with writing this book, and Shantanu Suman for his help supervising their team.

I want to thank Studio 165+, the Ball State University School of Art in Muncie, Indiana, and Grace Grutsch at St. Joseph Central Elementary School in Fort Wayne for all of their hard work.

I would also like to thank CS Kern for their assistance with printing. And a special thanks to The Community Foundation of Muncie & Delaware County and the Town of Yorktown Endowment Fund for the grant that supported this project.



